



INNOVATION

- NEW SoftClose® drawer door. Ultra smooth closing of the warming drawer. Thermador exclusive feature

PERFORMANCE

- Telescopic ball-bearing rails offer smooth handling and support up to 40 lbs
- Warming Mode with three convenient temperature settings
- Special Proof Mode
- Moisture selector controls humidity level in the drawer
- Concealed 450-watt heating element
- Spacious 2.3 cu.ft. cavity can hold and warm up to 20 dinner plates
- Drawer has open sides for easy and convenient access
- Automatic shut-off timer
- NEW Star-K certified

DESIGN

- NEW: side supports and door liner now in bold stainless steel design
- Built-in Warming Drawer is the perfect companion for any Thermador Wall Oven
- Premium touch control
- Blue digital display
- Modern angular design

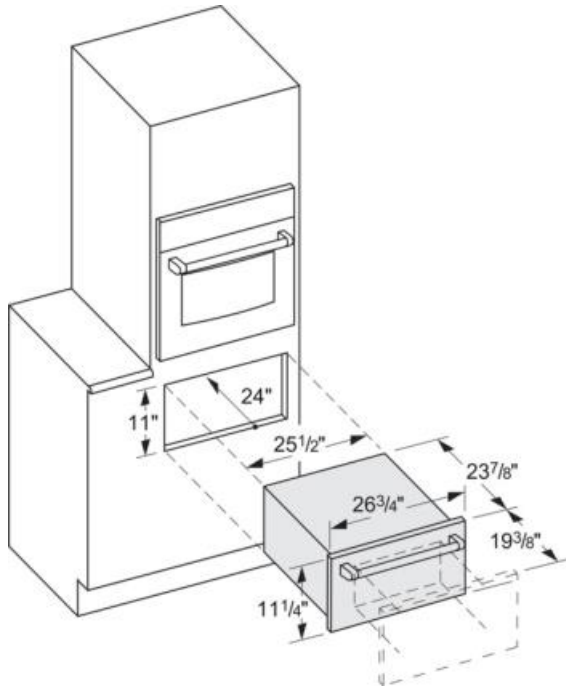

Amps (A)	15
Frequency (Hz)	60
Approval certificates	UL
Plug type	120V-3 prong
Net weight (lbs)	83
Power output heating	0.450
Power level	high, low, medium
Temperature control	electronic
Time control	No