



Design

- FREEDOM® Hinge enables true flush design
- Full height door - True cabinet integration without exposed venting grille
- ALL LED sidewall and theater lighting
- Accepts custom or stainless steel panels
- Reversible Door Swing

Performance

- Dedicated compressor and evaporator
- Electronic controls for precise temperature management
- Full length cantilever racks for ultimate adjustability
- Full Width Metal Freezer Shelves
- Full extension drawers at 90° door opening angle
- Oversized Freezer Basket
- Discrete and filtered ice-maker
- Ultra capacity ice drawer with flexible ice bin
- SuperFreeze - Freezes food quickly
- Sabbath mode
- Economy mode
- Vacation mode
- Door open alarm
- ENERGY STAR® Qualified
- 15.8 Cu. Ft.

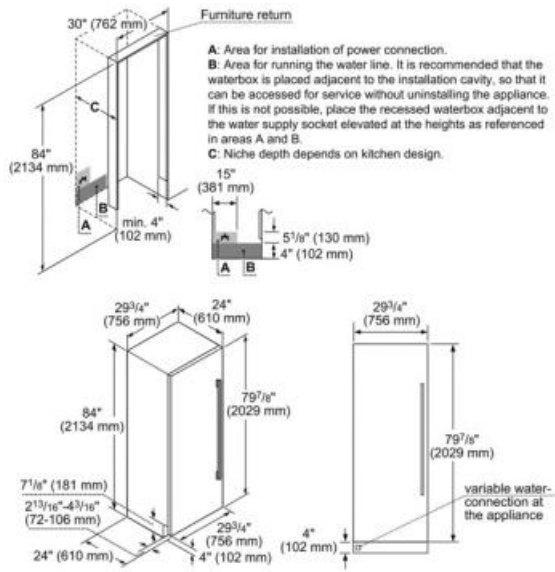

Amps (A)	10
Frequency (Hz)	60
Approval certificates	ETL, ETL C
Plug type	120V-3 prong
Net weight (lbs)	351
Gross weight (lbs)	387
Refrigerator gross capacity (cu.ft.)	0
Freezer gross capacity (cu.ft.)	16
Number of compressors	1
Optional accessories	FRAMEKIT10, HEATRKIT10, MS36HNDL10, PR36HNDL10, REPLFLTR10, SCRNFLTR10, TCH30IR800, TFL30IR800
Number of door bins - freezer	5
Number of shelves - freezer	3
Reversible door hinge	Yes